



EN

DE

1

INSTALLATION
INSTALLATION



2

CONNECTION PLANS
ANSCHLUSSPLÄNE



3

PRODUCT REGISTRATION
PRODUKTREGISTRIERUNG



4

TAPKEY APP
TAPKEY APP



5

SAFETY & SECURITY
SICHERHEITS- & GEFAHRENHINWEISE



tapkey SMART READER

Quick Start Guide
Kurzanleitung

PRODUCT CONTENTS
LIEFERUMFANG

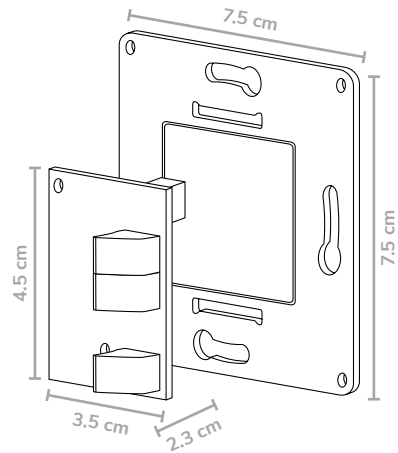

Tapkey Smart Reader electronics
Tapkey Smart Reader Elektronik

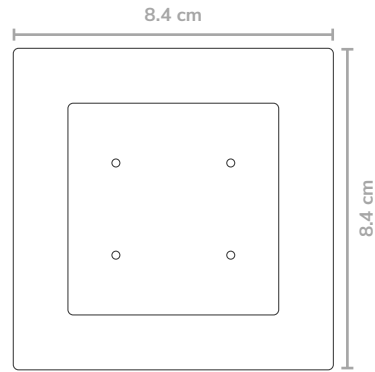

Frame & blind cover
Rahmen & Blindabdeckung

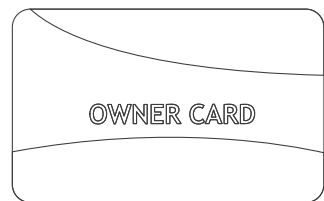

Owner Card for product registration
Owner Card für Produktregistrierung



NFC Tags (optional)
NFC Tags (optional)

This user guide is published by Tapkey GmbH or its local affiliated company, without any warranty. Improvements and changes to this user guide necessitated by typographical errors, inaccuracies of current information, or improvements to programs and/or equipment, may be made by Tapkey GmbH at any time and without notice. Such changes will, however, be incorporated into new editions of this user guide.

Diese Bedienungsanleitung wird ohne jegliche Gewährleistung von Tapkey GmbH oder einer regionalen Tochtergesellschaft veröffentlicht. Korrekturen und Änderungen dieser Bedienungsanleitung zur Beseitigung von Tippfehlern und inhaltlichen Ungenauigkeiten sowie aufgrund von Verbesserungen der Programme und/oder Geräte können von Tapkey GmbH jederzeit und ohne Ankündigung vorgenommen werden. Änderungen dieser Art werden in zukünftigen Ausgaben dieser Bedienungsanleitung berücksichtigt.

PRODUCT DETAILS
PRODUKTDDETAILS

Power supply Stromversorgung	AC 10–14 V, DC 6–19 V AC 10–14 V, DC 6–19 V
Recommended supply voltage Empfohlene Versorgungsspannung	12 VDC 12 VDC
Current consumption Stromaufnahme	max. 60 mA max. 60 mA
Battery for RTC Batterie für RTC	Battery must be recycled and kept separately from residual waste. Batterie recyceln und nicht im Restmüll entsorgen.
Temperature Temperaturbereich	–20 to +55 °C –20 bis +55 °C
Relative humidity Relative Feuchtigkeit	20–95 % (non-condensing) 20–95 % (nicht kondensierend)

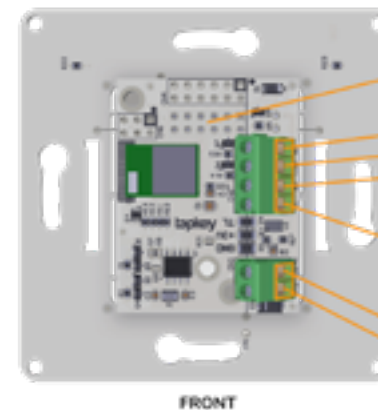

Connection cable (optional)

Relay
NC Normally Closed
COM Common
NO Normally Open

Contact rating
1 A at 30 VDC
300 mA at 125 VAC

TrigLock: trigger lock signal
When unlocked: input voltage from V-1 gets switched to TrigLock

V-2 Power input
V-1 6–19 VDC or 10–14 VAC
Reverse polarity protected



CR1220 coin cell battery
For realtime-clock

1

INSTALLATION INSTALLATION

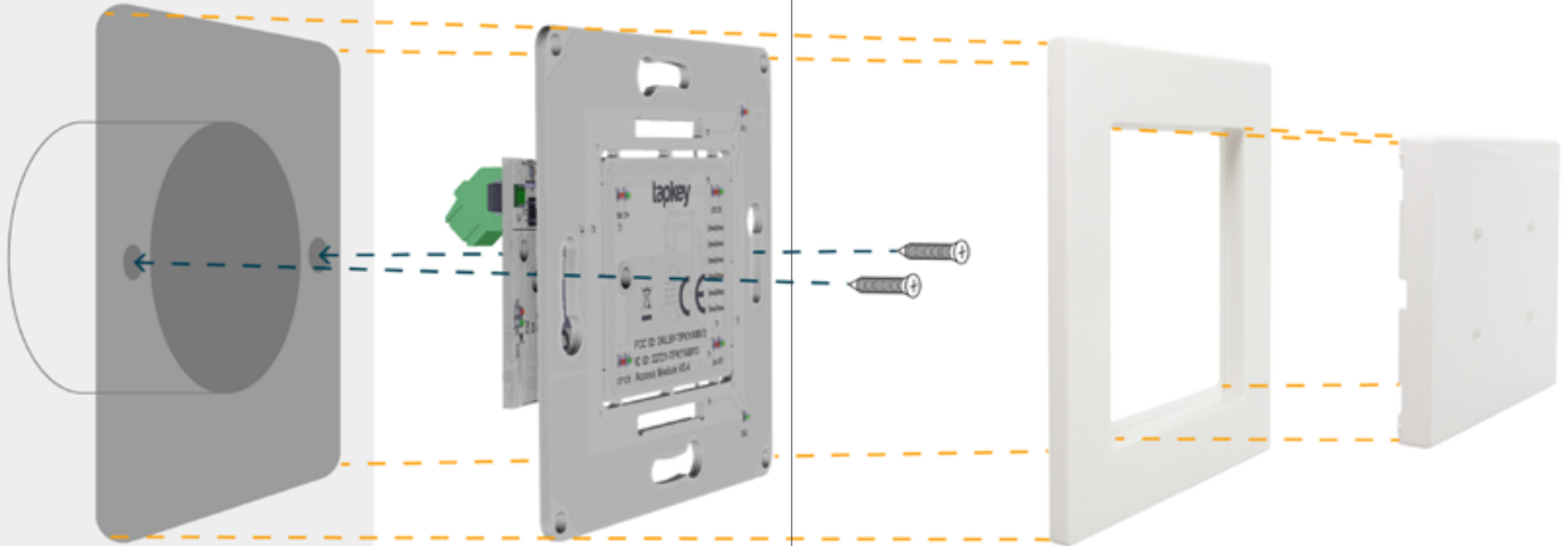

i We recommend installation by qualified personnel.
Montage von geschultem Fachpersonal empfohlen.

i We advise the use of a commercial flush-mounted box.
Wir empfehlen den Gebrauch einer handelsüblichen Unterputzdose.



Watch our step-by-step installation video
Schritt-für-Schritt Installationsvideo ansehen
tapkey.com/videoguide-smart-reader

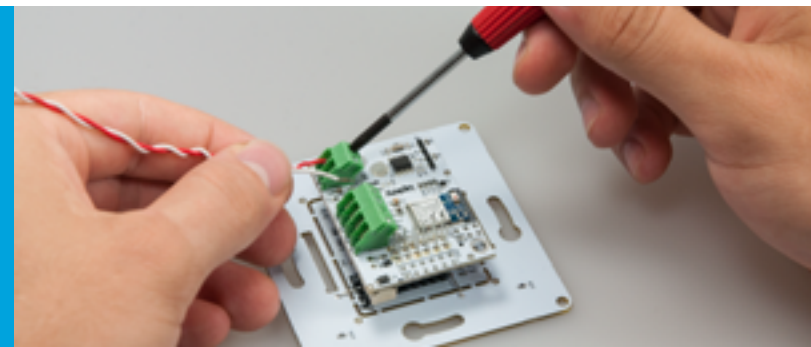



A. Trigger (i.e. garage door | potential-free)

A. Schalter (z.B. Garagentor | potentialfrei)

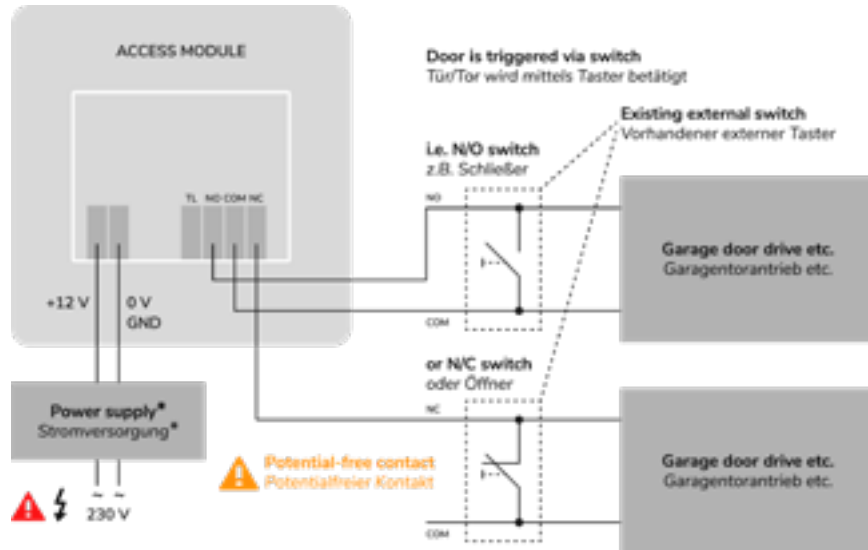

B. Installation with existing intercom including active door opener

B. Installation mit bestehender Gegensprechanlage inklusive Türöffner

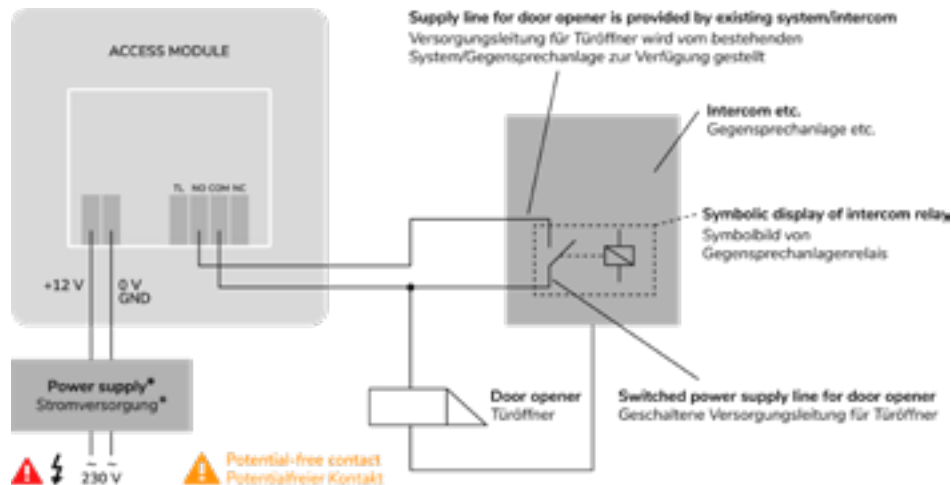

C. Installation with active door opener without existing intercom

C. Einbau mit aktivem Türöffner ohne bestehender Gegensprechanlage

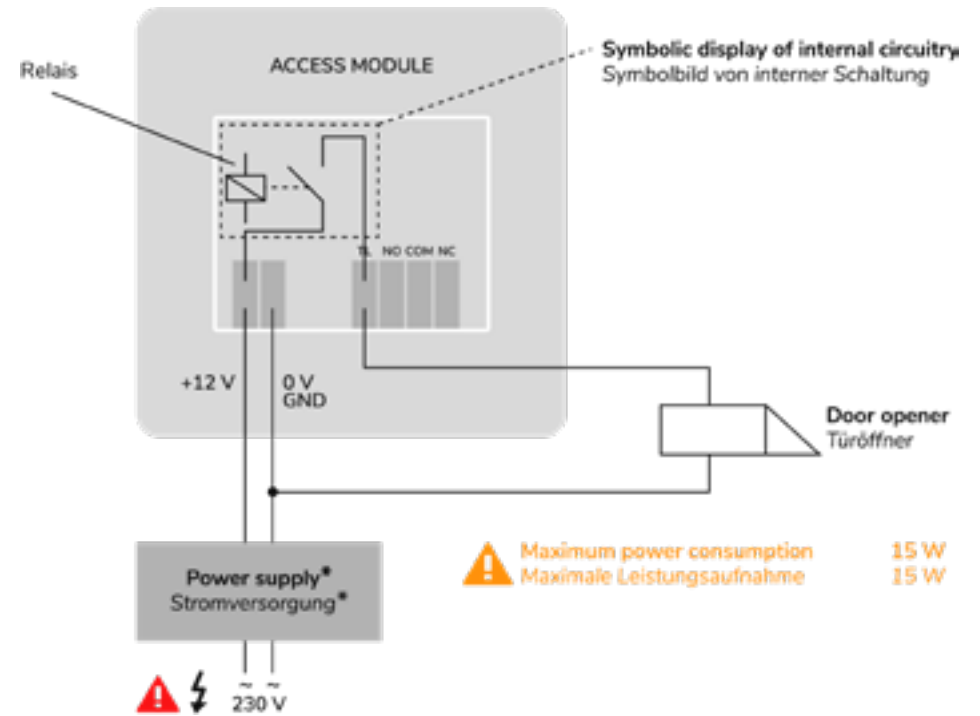

* Power supply

- › Not shipped with power supply unit
- › Short-circuit resistant
- › With fuse max. 15 W
- › Power input max. 60 mA at 12 VDC

Stromversorgung

- › Steckernetzteil nicht mitgeliefert
- › Kurzschlussfest
- › Bei Absicherung max. 15 W
- › Leistungsaufnahme des Elektronikmoduls max. 60 mA bei 12 VDC

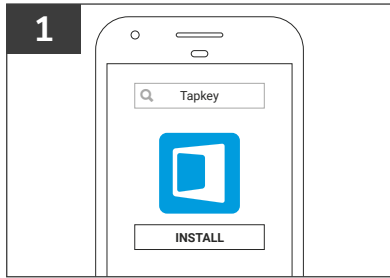

1
Install Tapkey App
Tapkey App installieren



2
Register or sign in
Registrieren oder anmelden

i Use your Google account, Apple ID or Tapkey ID
Google-Konto, Apple-ID oder Tapkey-ID verwenden

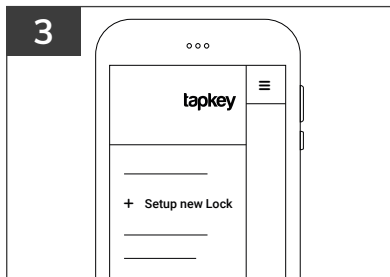

3
Set up new lock
Neues Schloss registrieren

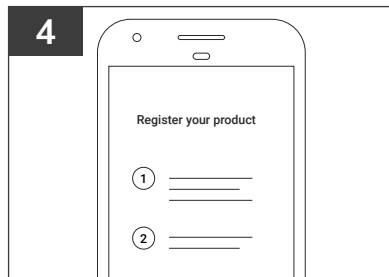

4
Follow instructions in the app
Anweisungen in der App folgen



CONGRATULATIONS! SMART READER SUCCESSFULLY INSTALLED.
GRATULATION! SMART READER ERFOLGREICH INSTALLIERT.



Your Tapkey products are easy and fun to use.
Tapkey-Produkte sind besonders einfach zu nutzen und verwalten.

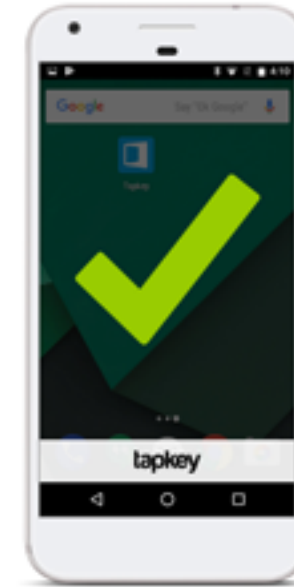

Create smartphone keys
Smartphone Keys erstellen



Program NFC transponders
NFC Transponder beschreiben



View access log
Zutrittsprotokoll ansehen



Update firmware
Firmware updaten



And much more
Und vieles mehr



Learn more about the Tapkey App
Erfahre mehr über die Tapkey App

tapkey.com/app

Manage access via Tapkey web portal
Zutritt verwalten via Tapkey Webportal

my.tapkey.com





General
Allgemein



Installation
Installation



Cleaning & maintenance
Reinigung & Pflege

Smart Reader electronics
Smart Reader Elektronik



Frame & blind cover
Rahmen & Blindabdeckung



Storage
Lagerung

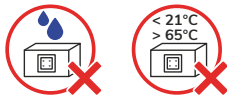

Certification
Zertifizierung



i For secure usage of your Tapkey Smart Reader and the connected smartphones and PCs please observe the security information at tapkey.com/security.

Für den sicheren Betrieb deines Tapkey Smart Readers und der damit genutzten Mobiltelefone und PCs bitte die Sicherheitshinweise unter tapkey.com/sicherheit beachten.

CANADA

IC: 22731-TPKYAM32

The Tapkey Access Module Version 3 can be used in Canada and complies with the applicable Industry Canada regulations.

INDUSTRY CANADA REGULATIONS

This device complies with Industry Canada's licence-exempt RSSs.

Operation is subject to the following two conditions:

- (1) This device may not cause interference; and
- (2) This device must accept any interference, including interference that may cause undesired operation of the device.

REGULATIONS INDUSTRIE CANADA

Le présent appareil est conforme aux CNR d'Industrie Canada applicables aux appareils radio exempts de licence. L'exploitation est autorisée aux deux conditions suivantes :

- (1) l'appareil ne doit pas produire de brouillage;
- (2) l'utilisateur de l'appareil doit accepter tout brouillage radio-électrique subi, même si le brouillage est susceptible d'en compromettre le fonctionnement.

UNITED STATES

FCC ID: 2AL5V-TPKYAM32

The Tapkey Access Module Version 3 can be used in the USA and complies with the applicable FCC rule parts.

FCC REGULATIONS

This device complies with part 15 of the FCC Rules. Operation is subject to the following two conditions:

- (1) This device may not cause harmful interference, and
- (2) this device must accept any interference received, including interference that may cause undesired operation.

Modifications

Any changes or modifications made to this device that are not expressly approved by Option could void the user's authority to operate the equipment.

EUROPE

Hereby, Tapkey declares that the radio equipment type Tapkey Access Module V3.4 is in compliance with the Directive 2014/53/EU. The full text of the EU declaration of conformity is available at the following internet address: tapkey.com

Hiermit erklärt Tapkey, dass der Funkanlagentyp Tapkey Access Module V3.4 der Richtlinie 2014/53/EU entspricht. Der vollständige Text der EU-Konformitätserklärung ist unter der folgenden Internetadresse verfügbar: tapkey.com

tapkey
the smart way in™

Tapkey GmbH
Brucknerstraße 2/6
A-1040 Wien

🖥️ tapkey.com

✉️ office@tapkey.com

☎️ +43 720 00 36 81